

KOMATSU

PC240LC-11 PC240NLC-11



Hydraulic excavator

Engine power

141 kW / 189 HP @ 2000 rpm

Operating weight

PC240LC-11: 25300 - 27530 kg
PC240NLC-11: 24700 - 26630 kg

Bucket capacity

max. 1.89 m³

PC240LC/NLC-11



Engine power
141 kW / 189 HP @ 2000 rpm

Operating weight
PC240LC-11: 25300 - 27530 kg
PC240NLC-11: 24700 - 26630 kg

Bucket capacity
max. 1.89 m³

Exceptional workability and environmental performance

Powerful and environmentally friendly

- EU Stage V engine
- Adjustable idle shutdown
- Komatsu fuel-saving technology

First-class comfort

- Fully air-suspended operator station
- Low-noise design
- Widescreen monitor

Maximised efficiency

- Increased productivity
- Built-in versatility and superior productivity
- Enhanced engine management
- Improved hydraulic efficiency
- Komatsu Integrated Attachment Control (KIAC)

Safety first

- Komatsu SpaceCab™
- KomVision surround view system
- Neutral position detection system

Quality you can rely on

- Komatsu-quality components
- Extensive dealer support network

Komtrax

- Komatsu Wireless Monitoring System
- 4G mobile communications
- Integrated communication antenna
- Increased operational data and reports



A maintenance program
for Komatsu customers



Higher productivity

The PC240LC/NLC-11 is quick and precise. It features a powerful Komatsu EU Stage V engine, Komatsu's Closed Center Load Sensing (CLSS) hydraulic system and first-class Komatsu comfort to provide a fast response and unrivalled productivity for its class.

Komatsu fuel-saving technology

Fuel consumption on the PC240LC/NLC-11 is lower by up to 6%. Engine management is enhanced. The variable speed matching of the engine and hydraulic pump and a viscous fan clutch guarantee efficiency and precision during single and combined movements.

Adjustable idle shutdown

The Komatsu auto idle shutdown automatically turns off the engine after it idles for a set period of time. This feature can easily be programmed from 5 to 60 minutes, to reduce unnecessary fuel consumption and exhaust emissions, and to lower operating costs. An Eco-gauge and the Eco guidance tips on the cab monitor further encourage efficient operations.

Powerful and environmentally friendly

Komatsu EU Stage V

The Komatsu EU Stage V engine is productive, dependable and efficient. With ultra-low emissions, it provides a lower environmental impact and a superior performance to help reduce operating costs and lets the operator work in complete peace of mind.



Heavy-duty aftertreatment

The aftertreatment system combines a Komatsu Diesel Particulate Filter (KDPF) and Selective Catalytic Reduction (SCR). The SCR injects the correct amount of AdBlue® into the system at the proper rate to break down NOx into water (H₂O) and non-toxic nitrogen gas (N₂). NOx emissions are reduced by 80% vs. EU Stage IIIB engines.

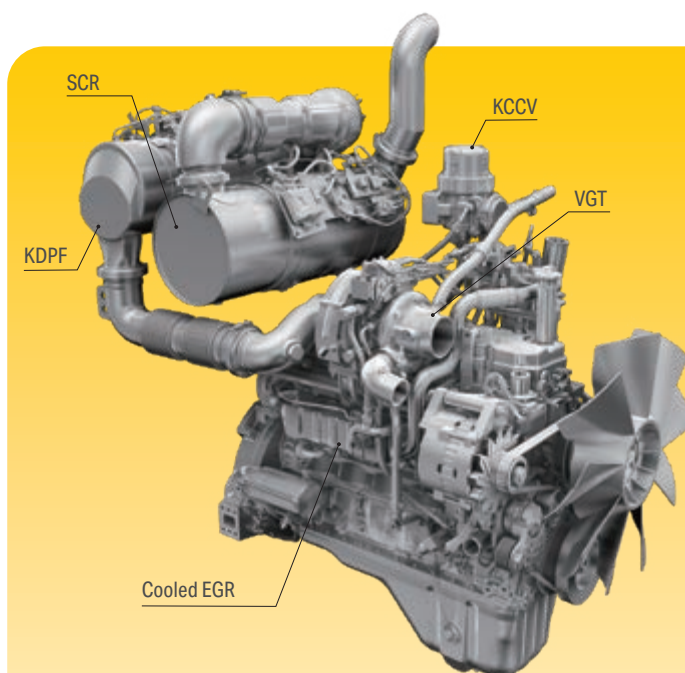
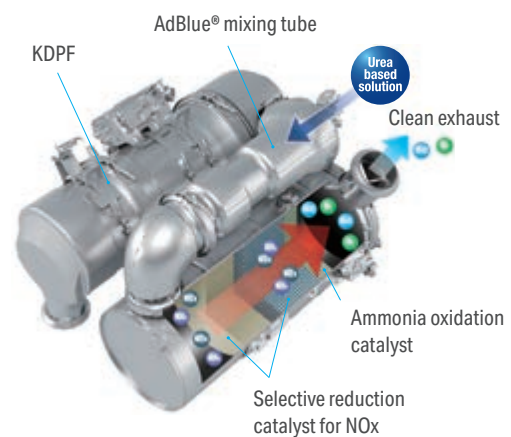

High-Pressure Common Rail (HPCR)

To achieve complete fuel burn and lower exhaust emissions, the heavy-duty High-Pressure Common Rail fuel injection system is computer controlled to deliver a precise quantity of pressurised fuel into the redesigned engine combustion chamber by multiple injections.

Exhaust Gas Recirculation (EGR)

Cooled EGR is a technology well-proven in current Komatsu engines. The increased capacity of the EGR cooler now ensures very low NOx emissions and a better engine performance.

Komatsu Closed Crankcase Ventilation (KCCV)

Crankcase emissions (blow-by gas) are passed through a CCV filter. The oil mist trapped in the filter is returned back to the crankcase while the filtered gas is returned to the air intake.

Variable Geometry Turbo (VGT)

The VGT provides optimal airflow to the engine combustion chamber under all speed and load conditions. Exhaust gas is cleaner, fuel economy is improved while machine power and performance are maintained.

PC240LC/NLC-11

A wide choice of options

Two optional attachment lines are available and 15 attachment memory settings are simply customised. Combined with a standard-fit hydraulic quick coupler power circuit, it's easier than ever to switch working styles. With a choice of arms and undercarriages, you can configure the PC240LC/NLC-11 to match specific demands for transport, working envelope or duty.

6 working modes

The PC240LC/NLC-11 delivers the power required with the lowest fuel usage. 6 working modes are available: Power, Lifting, Breaker, Economy, Attachment Power and Attachment Economy. The operator can ideally balance the Economy mode between power and economy to match the work at hand. The oil flow delivered to hydraulic attachments is also adjustable directly on the class-leading widescreen monitor panel.



Two-piece boom

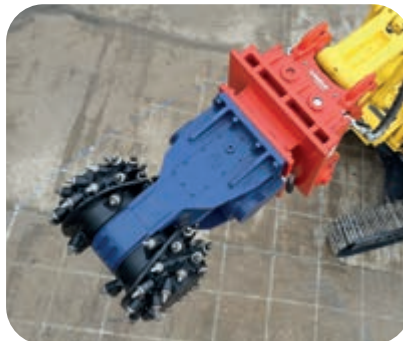

Two optional hydraulic lines to mount a variety of attachments

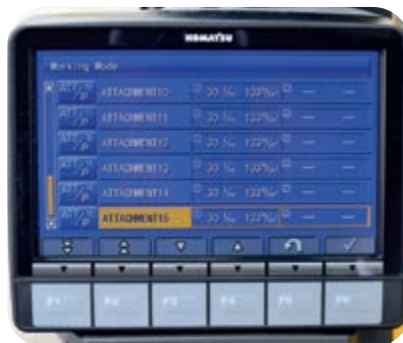

Komatsu Integrated Attachment Control (KIAC) for up to 15 tool presets for oil flow and pressure

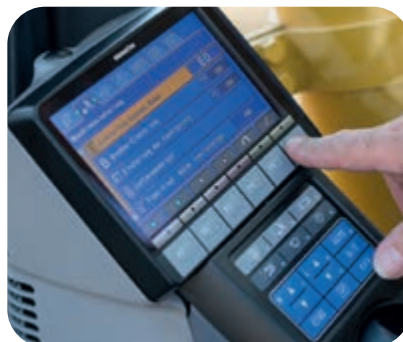

Versatility at your fingertips: select the perfect setting for each job





Maximised efficiency

Built-in versatility

Powerful and precise, the Komatsu PC240LC/NLC-11 is equipped to efficiently carry out any task your business requires. On all jobsites, big or small, for digging, trenching, landscaping or site preparation, the Komatsu hydraulic system always provides maximum productivity and control.

First-class comfort

Enhanced work environment

Designed to prioritise both productivity and operator well-being, the Komatsu crawler excavator cab features thoughtful ergonomics with high-visibility handrails, and improved interior LED lighting. Stepping inside reveals a sleek, dark colour scheme complemented by an effortlessly cleanable floor mat. Upgraded UV-protective tint on the cab rear window minimises sun exposure and helps maintain a cool working environment.

Future-proof customisable workspace

The operator cab offers extensive customisation possibilities. A multi-functional utility bar allows for adding personal accessories such as additional monitors or tablets, while dual USB ports (USB-A & USB-C) enable mobile device charging.



Convenient and secure entry to the spacious, well-insulated, low-noise cab



Multi-functional utility bar (items shown are for illustrative purposes only)



Optional premium seat with top quality cushioning, auto weight adjustment, lumbar support, climate control system, available with optional multi-position armrests and ergonomic control levers



Safety first

Optimal jobsite safety

Safety features on the Komatsu PC240LC/NLC-11 comply with the latest industry standards and work in synergy to minimise risks to people in and around the machine. A neutral detection system for travel and work equipment levers increase jobsite safety, along with a seat belt caution indicator and an audible travel alarm. Highly durable anti-slip plates – with additional high friction covering – maintain long term traction performance.



Safe maintenance

Thermal guards around high temperature areas of the engine, protected fan belt and pulleys, a pump/engine partition that prevents hydraulic oil from spraying onto the engine, a wide catwalk and exceptionally sturdy handrails: in Komatsu tradition, the highest safety level is provided for a fast and smooth maintenance.



Komatsu SpaceCab™

The ROPS cab has a tubular steel frame and provides high shock absorbercy, impact resistance and durability. The seat belt is well designed to keep the operator in the safety zone of the cab in the event of a rollover. Optionally the cab can be fitted with a Falling Object Protective System (FOPS) with openable front guard.



KomVision

KomVision machine visibility gives the operator a constant clear view of the safety zone around the machine. This allows the operator to focus on the work at hand even in low light conditions.



An evolutionary interface

Helpful information is now easier than ever to find and understand with the upgraded monitor interface. An optimal main screen for the ongoing work can be selected simply by pressing the F3 key.

Lower operating costs

Komatsu ICT contributes to the reduction of operating costs by assisting to comfortably and efficiently manage operations. It raises the level of customer satisfaction and the competitive edge of our products.

Widescreen monitor

Conveniently customisable and with a choice of 26 languages, the widescreen monitor with simple switches and multifunction keys gives fingertip access to a large range of functions and operating info. The rear camera view and an AdBlue® level gauge are now incorporated into the default main screen.



Quick view on the operation logs



With KomVision, various camera view options are available whilst maintaining constant "birdview" from above the machine



Operator identification function

Information & communication technology



Knowledge

You get quick answers to basic and critical questions about your machines – what they're doing, when they did it, where they're located, how they can be used more efficiently and when they need to be serviced. Performance data is relayed by wireless communication technology (satellite, GPRS or 4G depending on model) from the machine to a computer and to the local Komatsu distributor – who's readily available for expert analysis and feedback.

Convenience

Komtrax enables convenient fleet management on the web, wherever you are. Data is analysed and packaged specifically for effortless and intuitive viewing in maps, lists, graphs and charts. You can foresee eventual maintenance issues and required spare parts, and troubleshoot a problem before Komatsu technicians arrive on site.



The way to higher productivity

Komtrax uses the latest wireless monitoring technology. Compatible on PC, smartphone or tablet, it delivers insightful and cost saving information about your fleet and equipment, and offers a wealth of information to facilitate peak machine performance. By creating a tightly integrated web of support it allows proactive and preventive maintenance and helps to efficiently run a business.

Power

The detailed information that Komtrax puts at your fingertips 24 hours a day, 7 days a week gives the power to make better daily and long-term strategic decisions – at no extra cost. Problems can be anticipated, maintenance schedules customised, downtime minimised and machines kept where they belong: working on the jobsite.



Easy maintenance



Central service points

Komatsu designed the PC240LC/NLC-11 with centralised and conveniently located service points to make necessary inspections and maintenance quick and easy.

Komatsu Care

Komatsu Care is a maintenance program that comes as standard with your new Komatsu machine. It covers factory-scheduled maintenance, performed with Komatsu Genuine parts by Komatsu-trained technicians. Depending on your machine's engine, it also offers extended coverage of the Komatsu Diesel Particulate Filter (KDPF) and of the Selective Catalytic Reduction (SCR). Please contact your local Komatsu distributor for terms and conditions.

Long-life oil filters

The Komatsu Genuine hydraulic oil filter uses high-performance filtering material for long replacement intervals, which significantly reduces maintenance costs.



AdBlue® tank

For simple access, the AdBlue® tank is installed on the front stairway.

Flexible warranty

When you purchase Komatsu equipment, you gain access to a broad range of programmes and services that have been designed to help you get the most from your investment. For example, Komatsu's Flexible Warranty Programme provides a range of extended warranty options on the machine and its components. These can be chosen to meet your individual needs and activities. This programme is designed to help reduce total operating costs.

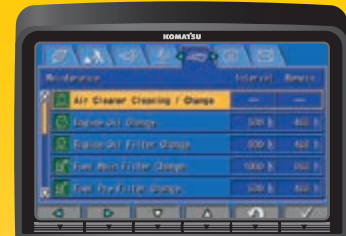

Basic maintenance screen

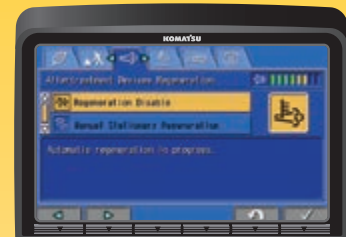

Aftertreatment device regeneration screen for the KDPF

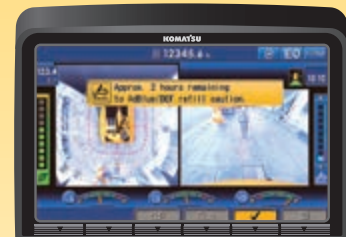

AdBlue® level and refill guidance



Quality you can rely on

Komatsu-quality

With the latest computer techniques and a thorough test programme, Komatsu produces equipment to meet your highest standards. All major components of the PC240LC/NLC-11 are designed and directly manufactured by Komatsu, and essential machine functions are perfectly matched for a highly reliable and productive excavator.

Rugged design

Maximum toughness and durability are the cornerstones of Komatsu's philosophy – along with safety and top class customer service. Single piece plates and castings are used in key areas of the machine's structure for good load distribution. Highly durable rubbing strips on the underside of the arm protect the structure against impact damage.

Extensive support network

The extensive Komatsu distribution and dealer network is standing by to help keep your fleet in optimum condition. Customised servicing packages are available, with express availability of spare parts, to make sure that your Komatsu equipment continues to perform at its peak.



Durable and reliable undercarriage design for maximum protection



Cast boom foot and single piece boom plates

Specifications

Engine

Model	Komatsu SAA6D107E-3
Type	Common rail direct injection, water-cooled, emissionised, turbocharged, after-cooled diesel
Engine power	
at rated engine speed	2000 rpm
ISO 14396	141 kW / 189 HP
ISO 9249 (net engine power)	132 kW / 177 HP
No. of cylinders	6
Bore × stroke	107 × 124 mm
Displacement	6.69 l
Air filter type	Double element type with monitor panel dust indicator and auto dust evacuator
Cooling	Suction type cooling fan with radiator fly screen
Fuel	Diesel fuel, conforming to EN590 Class 2/Grade D. Paraffinic fuel capability (HVO, GTL, BTL), conforming to EN 15940:2016

Hydraulic system

Type	HydrauMind. Closed-centre system with load sensing and pressure compensation valves
Additional circuits	2 additional circuits with proportional control can be installed
Main pump	2 variable displacement piston pumps supplying boom, arm, bucket, swing and travel circuits
Maximum pump flow	2 × 237.5 l/min
Relief valve settings	
Implement	380 kg/cm ²
Travel	380 kg/cm ²
Swing	295 kg/cm ²
Pilot circuit	33 kg/cm ²

Service refill capacities

Fuel tank	400 l
Radiator	36.0 l
Engine oil	23.1 l
Swing drive	7.2 l
Hydraulic tank	132 l
Final drive (each side)	5.0 l
AdBlue® tank	23.1 l

Swing system

Type	Axial piston motor driving through planetary double reduction gearbox
Swing lock	Electrically actuated wet multidisc brake integrated into swing motor
Swing speed	0 - 11.7 rpm
Swing torque	75 kNm

Drives and brakes

Steering control	2 levers with pedals giving full independent control of each track
Drive method	Hydrostatic
Travel operation	Automatic 3-speed selection
Gradeability	70%, 35°
Max. travel speeds	
Lo / Mi / Hi	3.0 / 4.1 / 5.5 km/h
Maximum drawbar pull	20570 kg
Brake system	Hydraulically operated discs in each travel motor

Undercarriage

Construction	X-frame centre section with box section track frames
Track assembly	
Type	Fully sealed
Shoes (each side)	51 (PC240LC), 49 (PC240NLC)
Tension	Combined spring and hydraulic unit
Rollers	
Track rollers (each side)	10 (PC240LC), 9 (PC240NLC)
Carrier rollers (each side)	2

Environment

Engine emissions	Fully complies with EU Stage V exhaust emission regulations
Noise levels	
LwA external	103 dB(A) (2000/14/EC Stage II)
LpA operator ear	70 dB(A) (ISO 6396 dynamic test)
Vibration levels (EN 12096:1997)	
Hand/arm	≤ 2.5 m/s ² (uncertainty K = 0.53 m/s ²)
Body	≤ 0.5 m/s ² (uncertainty K = 0.28 m/s ²)
Contains fluorinated greenhouse gas HFC-134a (GWP 1430). Quantity of gas 0.9 kg, CO ₂ equivalent 1.29 t	

Operating weight (appr.) – Mono boom

Triple grouser shoes	PC240LC-11		PC240NLC-11	
	Operating weight	Ground pressure	Operating weight	Ground pressure
600 mm	25300 kg	0.51 kg/cm ²	24700 kg	0.52 kg/cm ²
700 mm	25600 kg	0.44 kg/cm ²	25000 kg	0.45 kg/cm ²
800 mm	25900 kg	0.39 kg/cm ²	25300 kg	0.40 kg/cm ²
900 mm	26200 kg	0.35 kg/cm ²	-	-

Operating weight, including specified work equipment, 3.0 m arm, 735 kg bucket, operator, lubricant, coolant, full fuel tank and the standard equipment.

Operating weight (appr.) – Two-piece boom

Triple grouser shoes	PC240LC-11		PC240NLC-11	
	Operating weight	Ground pressure	Operating weight	Ground pressure
600 mm	26630 kg	0.54 kg/cm ²	26030 kg	0.55 kg/cm ²
700 mm	26930 kg	0.46 kg/cm ²	26330 kg	0.47 kg/cm ²
800 mm	27230 kg	0.41 kg/cm ²	26630 kg	0.42 kg/cm ²
900 mm	27530 kg	0.37 kg/cm ²	-	-

Operating weight, including specified work equipment, 3.0 m arm, 735 kg bucket, operator, lubricant, coolant, full fuel tank and the standard equipment.

Dimensions and performance figures

Machine dimensions	PC240LC-11	PC240NLC-11
A Overall width of upper structure	2705 mm	2705 mm
B Overall height of cab	3055 mm	3055 mm
C Overall length of basic machine	5305 mm	5210 mm
D Tail length	2985 mm	2985 mm
Tail swing radius	3020 mm	3020 mm
E Clearance under counterweight	1100 mm	1100 mm
F Machine tail height	2265 mm	2265 mm
F' Machine tail height (top of engine cover)	2780 mm	2780 mm
G Ground clearance	440 mm	440 mm
H Tumbler centre distance	3845 mm	3655 mm
I Track length	4640 mm	4450 mm
J Track gauge	2580 mm	2380 mm
K Track shoe width	600, 700, 800, 900 mm	600, 700, 800 mm
L Overall track width with 600 mm shoes	3180 mm	2980 mm
Overall track width with 700 mm shoes	3280 mm	3080 mm
Overall track width with 800 mm shoes	3380 mm	3180 mm
Overall track width with 900 mm shoes	3480 mm	-

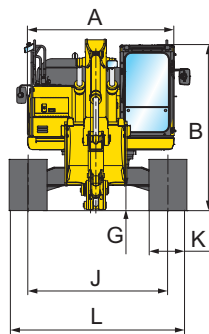

Mono boom

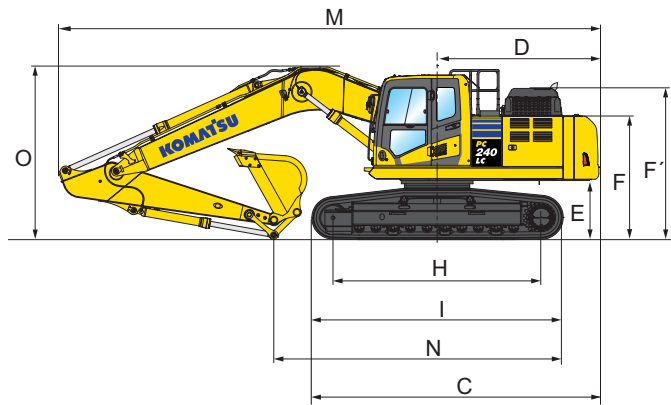

Two-piece boom

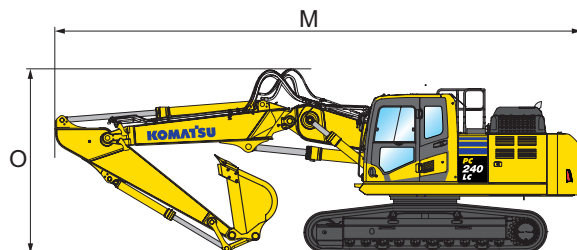

Transport dimensions	Mono boom				Two-piece boom		
Arm length	2.0 m	2.5 m	3.0 m	3.5 m	2.5 m	3.0 m	3.5 m
M Transport length	9945 mm	10040 mm	9965 mm	10010 mm	10170 mm	10120 mm	10100 mm
N Length on ground (transport) PC240LC	6600 mm	6115 mm	5390 mm	4950 mm	6795 mm	6170 mm	5895 mm
Length on ground (transport) PC240NLC	6460 mm	6020 mm	5260 mm	4860 mm	6700 mm	6700 mm	5800 mm
O Overall height (to top of boom) (to top of hose)	3220 mm	3295 mm	3185 mm	3270 mm	3445 mm	3540 mm	3680 mm

PC240LC-11 / Max. bucket capacity and weight

Arm length	Mono boom			
	2.0 m	2.5 m	3.0 m	3.5 m
Material weight up to 1.2 t/m ³	1.89 m ³ 1300 kg	1.89 m ³ 1300 kg	1.89 m ³ 1300 kg	1.82 m ³ 1250 kg
Material weight up to 1.5 t/m ³	1.89 m ³ 1300 kg	1.82 m ³ 1250 kg	1.64 m ³ 1175 kg	1.54 m ³ 1125 kg
Material weight up to 1.8 t/m ³	1.67 m ³ 1175 kg	1.58 m ³ 1125 kg	1.40 m ³ 1075 kg	1.33 m ³ 1025 kg

PC240NLC-11 / Max. bucket capacity and weight

Arm length	Mono boom			
	2.0 m	2.5 m	3.0 m	3.5 m
Material weight up to 1.2 t/m ³	1.89 m ³ 1300 kg	1.89 m ³ 1225 kg	1.70 m ³ 1125 kg	1.58 m ³ 1100 kg
Material weight up to 1.5 t/m ³	1.70 m ³ 1175 kg	1.59 m ³ 1125 kg	1.44 m ³ 1050 kg	1.34 m ³ 1000 kg
Material weight up to 1.8 t/m ³	1.47 m ³ 1075 kg	1.38 m ³ 1025 kg	1.20 m ³ 975 kg	1.16 m ³ 950 kg

PC240LC-11 / Max. bucket capacity and weight

Arm length	Two-piece boom		
	2.5 m	3.0 m	3.5 m
Material weight up to 1.2 t/m ³	2.16 m ³ 1405 kg	1.95 m ³ 1310 kg	1.83 m ³ 1255 kg
Material weight up to 1.5 t/m ³	1.83 m ³ 1255 kg	1.65 m ³ 1175 kg	1.55 m ³ 1130 kg
Material weight up to 1.8 t/m ³	1.58 m ³ 1150 kg	1.43 m ³ 1080 kg	1.34 m ³ 1040 kg

PC240NLC-11 / Max. bucket capacity and weight

Arm length	Two-piece boom		
	2.5 m	3.0 m	3.5 m
Material weight up to 1.2 t/m ³	1.95 m ³ 1310 kg	1.74 m ³ 1215 kg	1.65 m ³ 1175 kg
Material weight up to 1.5 t/m ³	1.65 m ³ 1175 kg	1.47 m ³ 1095 kg	1.39 m ³ 1060 kg
Material weight up to 1.8 t/m ³	1.43 m ³ 1080 kg	1.27 m ³ 1010 kg	1.21 m ³ 980 kg

Max. capacity and weight have been calculated according to ISO 10567:2007.

Please consult with your distributor for the correct selection of buckets and attachments to suit the application.

Bucket and arm force

Arm length	2.0 m	2.5 m	3.0 m	3.5 m
Bucket digging force	18800 kg	18800 kg	16200 kg	16200 kg
Bucket digging force at PowerMax	20100 kg	20100 kg	17500 kg	17500 kg
Arm crowd force	15300 kg	14100 kg	12300 kg	10500 kg
Arm crowd force at PowerMax	16400 kg	15100 kg	13200 kg	11200 kg

Working range

Mono boom

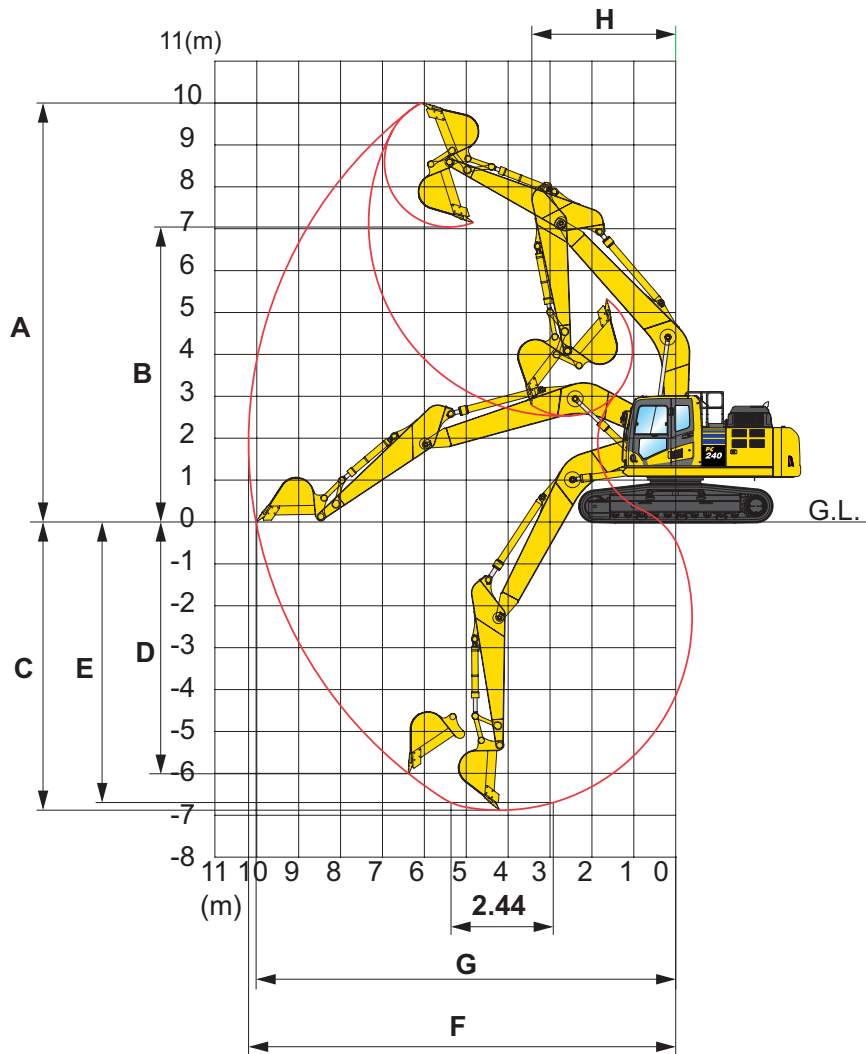

Working range

Arm length	2.0 m	2.5 m	3.0 m	3.5 m
A Max. digging height	9665 mm	9790 mm	10000 mm	10300 mm
B Max. dumping height	6715 mm	6860 mm	7035 mm	7360 mm
C Max. digging depth	5825 mm	6320 mm	6920 mm	7320 mm
D Max. vertical wall digging depth	4750 mm	5130 mm	6010 mm	6230 mm
E Max. digging depth of cut for 2.44 m level	5585 mm	6100 mm	6700 mm	7150 mm
F Max. digging reach	9270 mm	9670 mm	10180 mm	10580 mm
G Max. digging reach at ground level	9070 mm	9480 mm	10020 mm	10420 mm
H Min. swing radius	3300 mm	3320 mm	3450 mm	3340 mm

Two-piece boom

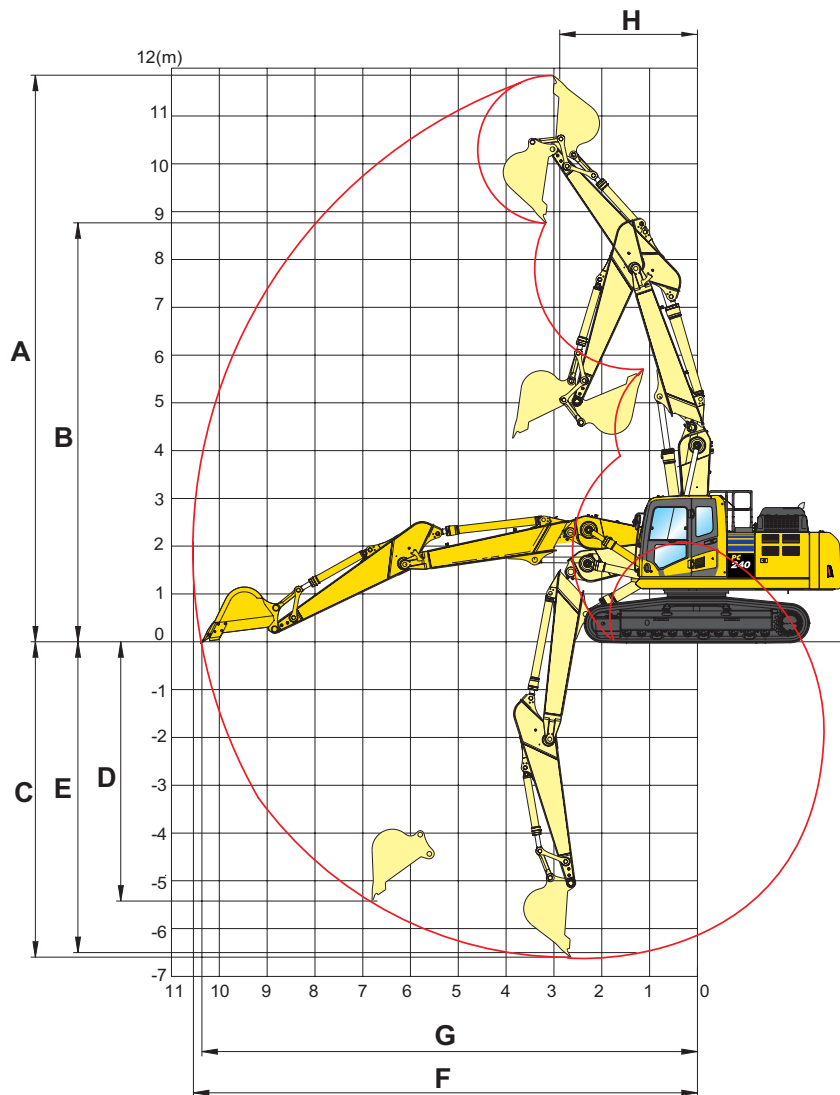

Working range

Arm length	2.5 m	3.0 m	3.5 m
A Max. digging height	11360 mm	11855 mm	12180 mm
B Max. dumping height	8265 mm	8745 mm	9245 mm
C Max. digging depth	6130 mm	6600 mm	7035 mm
D Max. vertical wall digging depth	4800 mm	5430 mm	5765 mm
E Max. digging depth of cut for 2.44 m level	6030 mm	6505 mm	6950 mm
F Max. digging reach	10000 mm	10550 mm	10965 mm
G Max. digging reach at ground level	9885 mm	10380 mm	10790 mm
H Min. swing radius	2945 mm	2875 mm	3005 mm

Lifting capacity

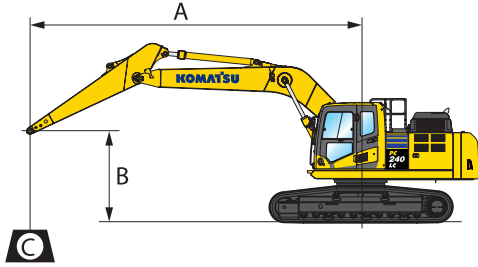

A – Reach from swing center

B – Bucket hook height

C – Lifting capacities

– Rating over front

– Rating over side

– Rating at maximum reach

Weights:

With 2.0 and 2.5 m arm:
bucket linkage and
bucket cylinder: 390 kg
With 3.0 and 3.5 m arm:
bucket linkage and
bucket cylinder: 363 kg

PC240LC-11 Mono boom

With 700 mm shoes

Arm length	A				9.0 m		7.5 m		6.0 m		4.5 m		3.0 m		1.5 m		
	B																
 3.5 m	6.0 m	kg	*3870	*3870			*5520	5100	*5740	*5740							
	4.5 m	kg	*3860	*3860			*6380	5000	*6630	*6630							
	3.0 m	kg	*3990	3700			*7050	4840	*7950	6690	*9860	*9860	*15240	*15240			
	1.5 m	kg	*4250	3580			6890	4660	*9340	6350	*12530	9500					
	0.0 m	kg	*4710	3630			6730	4510	9320	6080	*14310	9050	*8510	*8510			
	-1.5 m	kg	*5490	3870			6640	4440	9160	5940	14570	8870	*12140	*12140	*7760	*7760	
	-3.0 m	kg	6590	4410			6670	4460	9140	5930	14590	8880	*17390	*17390	*11910	*11910	
	-4.5 m	kg	8640	5690					9310	6070							
 3.0 m	6.0 m	kg	*4460	*4460			*4990	*4990	*6370	*6370							
	4.5 m	kg	*4440	4290			*6870	4970	*7240	6960	*8150	*8150					
	3.0 m	kg	*4590	3960			7070	4830	*8520	6650	*10840	10080					
	1.5 m	kg	*4910	3850			6900	4680	9600	6340	*13340	9440					
	0.0 m	kg	*5480	3910			6770	4560	9360	6130	*14800	9100	*7560	*7560			
	-1.5 m	kg	6220	4210			6710	4510	9240	6030	14700	8990	*12510	*12510	*8160	*8160	
	-3.0 m	kg	7310	4890					9270	6050	*14660	9040	*19180	17770	*13240	*13240	
	-4.5 m	kg															
 2.5 m	6.0 m	kg	*6610	5530					*7080	7050							
	4.5 m	kg	*6620	4710			7130	4890	*7880	6840	*9180	*9180					
	3.0 m	kg	6300	4310			7000	4770	*9090	6550	*11850	9830					
	1.5 m	kg	6130	4180			6860	4640	9510	6270	*14080	9280					
	0.0 m	kg	6310	4270			6760	4550	9310	6090	14750	9030					
	-1.5 m	kg	6930	4660					9250	6030	14710	9000	*13550	*13550			
	-3.0 m	kg	8460	5600					9340	6110	*14160	9120	*19730	17970			
	-4.5 m	kg															
 2.0 m	6.0 m	kg	*7010	6100					*7810	6980	*8190	*8190					
	4.5 m	kg	*6960	5110					*8500	6800	*10170	*10170					
	3.0 m	kg	6800	4650			7000	4780	*9630	6520	*12840	9700					
	1.5 m	kg	6620	4510			6890	4680	9520	6280	*14770	9240					
	0.0 m	kg	6860	4640					9370	6150	14820	9100					
	-1.5 m	kg	7650	5130					9350	6130	14850	9130	*13800	*13800			
	-3.0 m	kg															
	-4.5 m	kg															

* Load is limited by hydraulic capacity rather than tipping. Ratings are based on SAE Standard No. J1097.
Rated loads do not exceed 87% of hydraulic lift capacity or 75% of tipping load. Lifting capacity stated is based on lifting with bare arm.
When lifting with additional equipment installed to the arm, please subtract the weight of all additional equipment from the values stated.

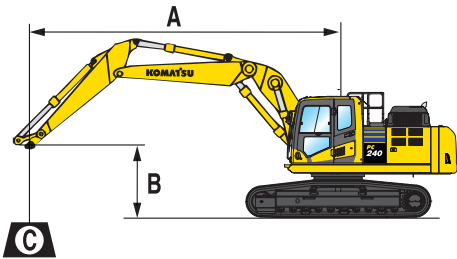

A – Reach from swing center

B – Bucket hook height

C – Lifting capacities

– Rating over front

– Rating over side

– Rating at maximum reach

Weights:

With 2.5 m arm: bucket linkage

and bucket cylinder: 390 kg

With 3.0 and 3.5 m arm: bucket linkage

and bucket cylinder: 363 kg

PC240LC-11 Two-piece boom

With 700 mm shoes

Arm length	A				9.0 m		7.5 m		6.0 m		4.5 m		3.0 m		1.5 m	
	B															
 3.5 m	7.5 m	kg	*4000	*4000			*4250	*4250	*6450	*6450						
	6.0 m	kg	*3750	*3750			*6300	4900	*6750	*6750	*6300	*6300				
	4.5 m	kg	*3700	3500			*6950	4750	*7650	6750	*8200	*8200	*7950	*7950		
	3.0 m	kg	*3750	3250			6850	4600	*8750	6350	*11200	9700				
	1.5 m	kg	*3900	3200			6650	4400	9300	6000	*13200	8950				
	0.0 m	kg	*4200	3250			6500	4250	9000	5700	14300	8500				
	-1.5 m	kg	*4700	3450			6450	3850	8850	5600	14150	8400	*9500	*9500		
-3.0 m	kg					6500	3900	8900	5650	*13700	8450					
 3.0 m	7.5 m	kg	*4650	*4650					*7200	7000	*7350	*7350				
	6.0 m	kg	*4350	4300			6600	4800	*7400	6900	*7550	*7550				
	4.5 m	kg	*4250	3750			7000	4750	*8150	6650	*9750	*9750				
	3.0 m	kg	*4300	3500			6850	4550	*9250	6300	*12050	9550				
	1.5 m	kg	*4500	3450			6650	4400	9300	6000	*13800	8900				
	0.0 m	kg	*4850	3500			6550	4300	9050	5750	14350	8600				
	-1.5 m	kg	*5450	3750			6500	3900	8950	5700	14300	8550	*9650	*9650		
-3.0 m	kg							9050	5750	*13300	8650					
 2.5 m	7.5 m	kg	*7050	6250					*7950	6800	*8200	*8200				
	6.0 m	kg	*6550	4800					*7950	6750	*8900	*8900				
	4.5 m	kg	6200	4150			6950	4650	*8700	6500	*10650	10100				
	3.0 m	kg	5750	3850			6800	4500	9500	6200	*12850	9300				
	1.5 m	kg	5600	3750			6650	4400	9200	5900						
	0.0 m	kg	5750	3850			6550	4300	9000	5750	14300	8550				
	-1.5 m	kg	6350	4200			6550	3900	9000	5700	*14150	8600				
-3.0 m	kg															

* Load is limited by hydraulic capacity rather than tipping. Ratings are based on SAE Standard No. J1097.

Rated loads do not exceed 87% of hydraulic lift capacity or 75% of tipping load. Lifting capacity stated is based on lifting with bare arm.

When lifting with additional equipment installed to the arm, please subtract the weight of all additional equipment from the values stated.

Lifting capacity

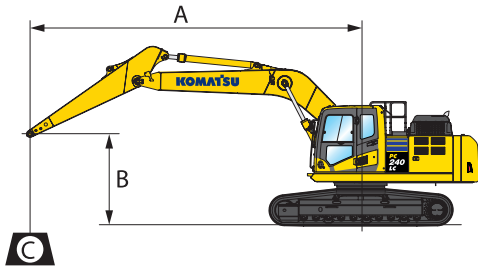

A – Reach from swing center

B – Bucket hook height

C – Lifting capacities

– Rating over front

– Rating over side

– Rating at maximum reach

Weights:

With 2.0 and 2.5 m arm:
bucket linkage and
bucket cylinder: 390 kg
With 3.0 and 3.5 m arm:
bucket linkage and
bucket cylinder: 363 kg

PC240NLC-11 Mono boom

With 600 mm shoes

Arm length	A				9.0 m		7.5 m		6.0 m		4.5 m		3.0 m		1.5 m	
	B															
 3.5 m	6.0 m	kg	*3870	*3870			*5520	4580	*5740	*5740						
	4.5 m	kg	*3860	3560			*6380	4480	*6630	6300						
	3.0 m	kg	*3990	3290			6420	4320	*7950	5970	*9860	9050	*15240	*15240		
	1.5 m	kg	*4250	3180			6230	4140	8660	5630	*12530	8350				
	0.0 m	kg	*4710	3220			6070	4000	8370	5370	13120	7910	*8510	*8510		
	-1.5 m	kg	5180	3430			5990	3920	8220	5240	12910	7740	*12140	*12140	*7760	*7760
	-3.0 m	kg	5950	3910			6010	3950	8200	5220	12920	7750	*17390	14820	*11910	*11910
	-4.5 m	kg	7770	5030					8360	5360						
 3.0 m	6.0 m	kg	*4460	4420			*4990	4520	*6370	*6370						
	4.5 m	kg	*4440	3830			6560	4450	*7240	6240	*8150	*8150				
	3.0 m	kg	*4590	3530			6410	4320	*8520	5930	*10840	8920				
	1.5 m	kg	*4910	3420			6240	4160	8650	5630	*13340	8300				
	0.0 m	kg	5210	3480			6120	4050	8410	5420	13160	7960	*7560	*7560		
	-1.5 m	kg	5630	3730			6060	4000	8300	5320	13030	7860	*12510	*12510	*8160	*8160
	-3.0 m	kg	6600	4340					8320	5340	13100	7910	*19180	15150	*13240	*13240
	-4.5 m	kg														
 2.5 m	6.0 m	kg	*6610	4950					*7080	6320						
	4.5 m	kg	6220	4210			6470	4370	*7880	6120	*9180	*9180				
	3.0 m	kg	5710	3840			6340	4260	8870	5830	*11850	8680				
	1.5 m	kg	5550	3710			6200	4130	8570	5560	13370	8140				
	0.0 m	kg	5710	3790			6110	4040	8370	5380	13090	7900				
	-1.5 m	kg	6260	4130					8310	5330	13050	7870	*13550	*13550		
	-3.0 m	kg	7620	4960					8390	5400	13180	7980	*19730	15330		
	-4.5 m	kg														
 2.0 m	6.0 m	kg	*7010	5460					*7810	6250	*8190	*8190				
	4.5 m	kg	6770	4570					*8500	6080	*10170	9230				
	3.0 m	kg	6170	4150			6340	4260	8840	5810	*12840	8560				
	1.5 m	kg	6000	4010			6230	4160	8570	5570	13320	8110				
	0.0 m	kg	6200	4120					8420	5440	13150	7970				
	-1.5 m	kg	6910	4560					8400	5420	13180	8000	*13800	*13800		
	-3.0 m	kg														
	-4.5 m	kg														

* Load is limited by hydraulic capacity rather than tipping. Ratings are based on SAE Standard No. J1097.
Rated loads do not exceed 87% of hydraulic lift capacity or 75% of tipping load. Lifting capacity stated is based on lifting with bare arm.
When lifting with additional equipment installed to the arm, please subtract the weight of all additional equipment from the values stated.

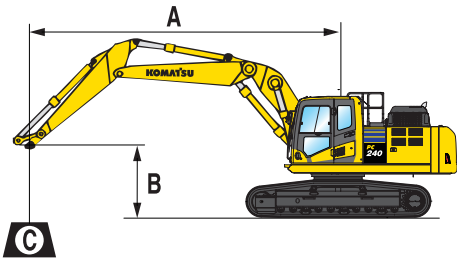

A – Reach from swing center

B – Bucket hook height

C – Lifting capacities

– Rating over front

– Rating over side

– Rating at maximum reach

Weights:

With 2.5 m arm: bucket linkage

and bucket cylinder: 390 kg

With 3.0 and 3.5 m arm: bucket linkage

and bucket cylinder: 363 kg

PC240NLC-11 Two-piece boom

With 700 mm shoes

Arm length	A				9.0 m		7.5 m		6.0 m		4.5 m		3.0 m		1.5 m	
	B															
 3.5 m	7.5 m	kg	*4000	*4000			*4250	*4250	*6450	6400						
	6.0 m	kg	*3750	3500			*6300	4350	*6750	6250	*6300	*6300				
	4.5 m	kg	*3700	3100			6400	4250	*7650	6000	*8200	*8200	*7950	*7950		
	3.0 m	kg	*3750	2850			6200	4050	8750	5600	*11200	8550				
	1.5 m	kg	*3900	2800			6000	3850	8350	5250	12950	7800				
	0.0 m	kg	*4200	2850			5850	3700	8050	5000	12600	7400				
	-1.5 m	kg	*4700	3050			5750	3300	7900	4900	12450	7250	*9500	*9500		
-3.0 m	kg					5800	3350	7950	4900	12550	7350					
 3.0 m	7.5 m	kg	*4650	*4650					*7200	6250	*7350	*7350				
	6.0 m	kg	*4350	3800			6450	4300	*7400	6200	*7550	*7550				
	4.5 m	kg	*4250	3350			6350	4200	*8150	5900	*9750	9200				
	3.0 m	kg	*4300	3100			6200	4050	8700	5600	*12050	8400				
	1.5 m	kg	*4500	3000			6000	3900	8350	5250	12900	7750				
	0.0 m	kg	4750	3100			5900	3800	8100	5050	12700	7450				
	-1.5 m	kg	5150	3300			5850	3750	8000	5000	12650	7400	*9650	*9650		
-3.0 m	kg							8100	5050	12800	7500					
 2.5 m	7.5 m	kg	*7050	5550					*7950	6050	*8200	*8200				
	6.0 m	kg	6500	4250					*7950	6050	*8900	*8900				
	4.5 m	kg	5600	3650			6250	4100	*8700	5800	*10650	8900				
	3.0 m	kg	5150	3400			6100	4000	8550	5450	*12850	8150				
	1.5 m	kg	5050	3300			5950	3850	8250	5200						
	0.0 m	kg	5200	3350			5900	3800	8050	5050	12650	7400				
	-1.5 m	kg	5700	3700			5900	3470	8050	5000	12650	7450				
-3.0 m	kg															

* Load is limited by hydraulic capacity rather than tipping. Ratings are based on SAE Standard No. J1097.

Rated loads do not exceed 87% of hydraulic lift capacity or 75% of tipping load. Lifting capacity stated is based on lifting with bare arm.

When lifting with additional equipment installed to the arm, please subtract the weight of all additional equipment from the values stated.

Standard and optional equipment

Engine

Komatsu SAA6D107E-3 turbocharged common rail direct injection diesel engine	●
EU Stage V compliant	●
Suction type cooling fan with radiator fly screen	●
Automatic engine warm-up system	●
Engine overheat prevention system	●
Fuel control dial	●
Auto-deceleration function	●
Adjustable idle shutdown	●
Engine key stop	●
Engine ignition can be password secured on request	●
Alternator 24 V / 90 A	●
Starter motor 24 V / 5.5 kW	●
Batteries 2 × 12 V / 180 Ah	●

Hydraulic system

Electronic closed-centre load sensing (E-CLSS) hydraulic system (HydraMind)	●
Pump and engine mutual control (PEMC) system	●
6-working mode selection system; Power mode, Economy mode, Breaker mode, Attachment Power and Attachment Economy mode, and Lifting mode	●
PowerMax function	●
PPC wrist control levers for arm, boom, bucket and swing, with sliding proportional control for attachments and 3 auxiliary buttons	●
Prepared for hydraulic quick-coupler	●
Additional hydraulic functions	○
Komatsu Integrated Attachment Control (KIAC)	○

Undercarriage

Track roller guards	●
Track frame under-guards	●
600, 700, 800, 900 mm triple grouser shoes	○
Full length track roller guards	○

Drives and brakes

Hydrostatic, 3-speed travel system with automatic shift and planetary gear type final drives, and hydraulic travel and parking brakes	●
PPC control levers and pedals for steering and travel	●

Cabin

Reinforced safety SpaceCab™; highly pressurised and tightly sealed hyper viscous mounted cab with tinted safety glass windows, large roof window with sun shade, pull-up type front window with locking device, removable lower window, front window wiper with intermittent feature, sun roller blind, cigarette lighter, ashtray, luggage shelf, std. floor mat, additional floor mat	●
Heated, high-back air-suspended seat with lumbar support, console mounted height adjustable arm rests, and retractable seat belt	●
Automatic climate control system	●
12 / 24 Volt power supplies	●
USB-A / USB-C power supplies	●
Utility bar	●
Beverage holder and magazine rack	●
Hot and cool box	●
DAB+ radio with Bluetooth®, USB, AUX and hands-free kit	●
Premium comfort seat	○
Lower wiper	○
Rain visor (not with OPG)	○

Service and maintenance

Automatic fuel line de-aeration	●
Double element type air cleaner with dust indicator and auto dust evacuator	●
Komtrax – Komatsu wireless monitoring system (4G)	●
Komatsu Care – a maintenance program for Komatsu customers	●
Multifunction video compatible colour monitor with Equipment Management and Monitoring System (EMMS) and efficiency guidance	●
Toolkit	●
Service points	○
Automatic greasing system	○

LED lighting system

Working lights: 2 revolving frame, 1 boom (l.h.)	●
Coming home light function	●
Additional working lights (#1): 2 cab roof (front), 1 cab roof (rear), 1 boom (r.h.), 1 counterweight, beacon	○
Additional working lights (#2): 4 cab roof (front), 1 cab roof (rear), 1 boom (r.h.), 1 counterweight, 2 boom cylinders, 2 revolving frame (l.h. + r.h.), beacon	○

Safety equipment

KomVision surround view system	●
Electric horn	●
Overload warning device	●
Audible travel alarm	●
Boom safety valves	●
Large handrails	●
Rear-view mirrors (for cab adjustable without tools)	●
Battery main switch	●
ROPS compliant to ISO 12117-2:2008	●
Emergency engine stop switch	●
Seat belt caution indicator	●
Neutral position detection system	●
Arm safety valve	●
OPG Level II front guard (FOPS), hinged type	○
OPG Level II top guard (FOPS)	○

Work equipment

Mono boom	○
Two-piece boom	○
Bucket linkage with lifting eye	○
2.0 m; 2.5 m; 3.0 m; 3.5 m arms	○
Komatsu buckets	○
Komatsu breakers	○

Other equipment

Standard counterweight	●
Remote greasing for swing circle and pins	●
Electric refuelling pump with automatic shut-off function	●
Biodegradable oil for hydraulic system	○
Customised paint	○

Further equipment on request

- standard equipment
- optional equipment



A wide range of buckets and attachments is available. Your Komatsu distributor is ready to assist you with the selection of suitable options.

This specification sheet may contain attachments and optional equipment that are not available in your area. Please consult your local Komatsu distributor for those items you may require. Materials and specifications are subject to change without notice.

Your Komatsu partner:

KOMATSU

[komatsu.eu](https://www.komatsu.eu)

